

KONZENTRISCHES LUFT-ABGASSYSTEM (LIL)

DN 60/100 – DN 200/300 mm

PPH/Stahl weiß pulverbeschichtet

1	LIL-Abdeckblende zweiteilig
2	LIL -Rohr mit Muffe
3	LIL-Schieberohr mit Klemmband
4	LIL-Rev. T-Stück
5	LIL-Umlenk. T-Stück
6	LIL-Mess-Stück reduziert

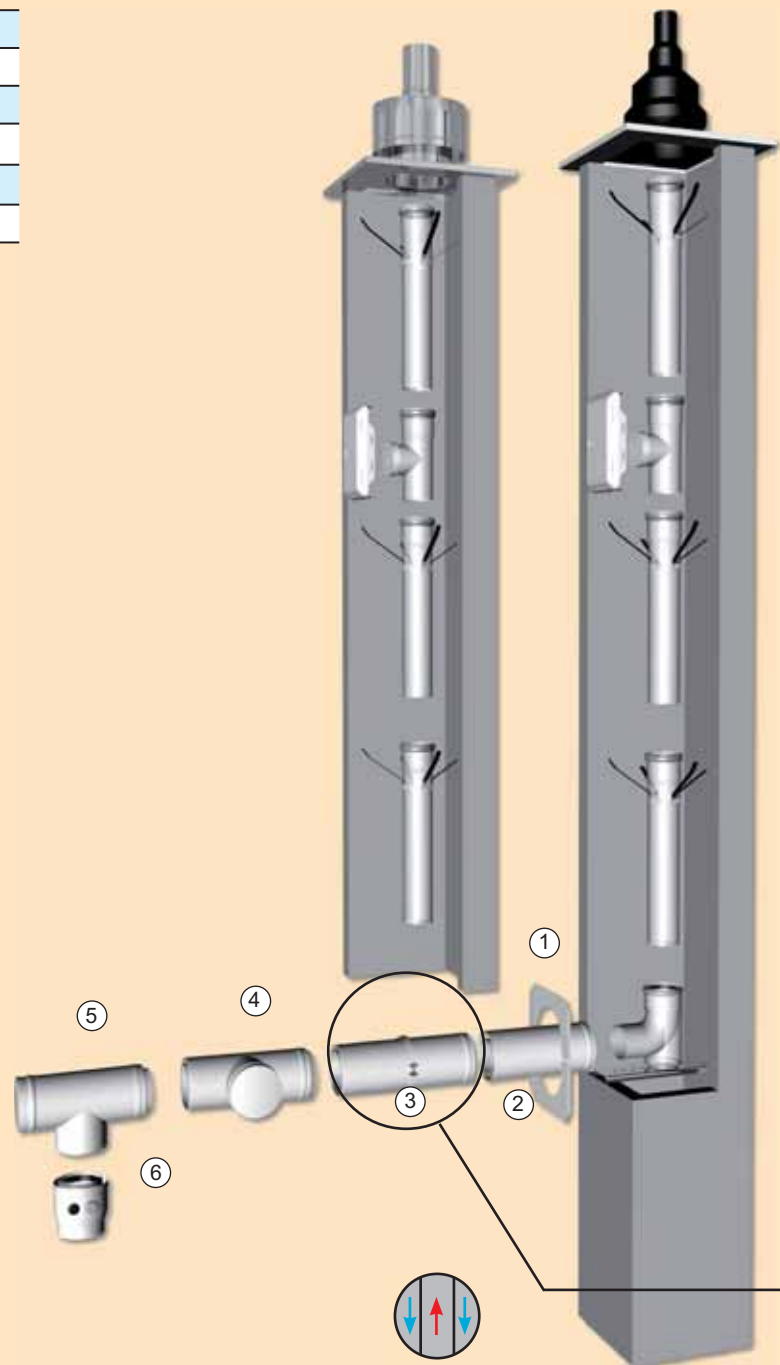

Gefälle schaffen

! waagerechte Verbindungsleitung muss zum Kessel immer ein Gefälle von mindestens 3° haben

KONZENTRISCHES LUFT-ABGASSYSTEM (LIL)

DN 60/100 – DN 200/300 mm

PPH/Stahl weiß pulverbeschichtet

Kesselanschlüsse in 3 Varianten:

Variante I



LIL-Kesseladapter

NW (Abgasleitung)	NW (Kesselstutzen)
60/100	63/96
80/125	60/100
110/160	70/100
125/180	70/110
160/225	80/110
200/300	80/122
	80/125
	80/126
	80/130
	100/150
	110/160
	125/180
	160/225

Variante II



LIL-Mess-Stück reduziert

NW (Abgasleitung)	NW (Kesselstutzen)
60/100	63/96
80/125	60/100
110/160	70/110
125/180	80/110
160/225	80/125
200/300	80/126
	80/130
	100/150
	110/160
	125/180
	160/225

Variante III



LIL-Umlenk-T-Stück
als Kesselanschluß

NW (Abgasleitung)	NW (Kesselstutzen)
60/100	63/96
80/125	60/100
110/160	70/110
125/180	80/110
160/225	80/125
200/300	80/126
	80/130
	100/150
	110/160
	125/180
	160/225

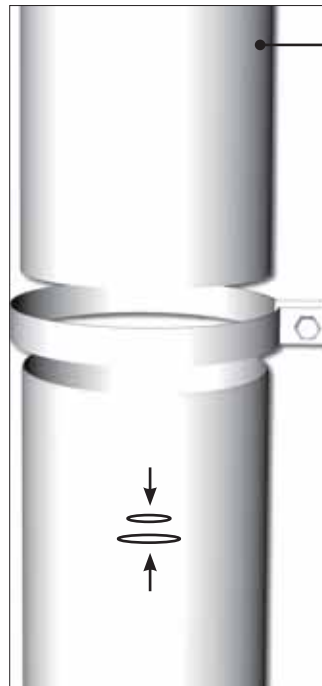

Beide Rohrteile des Schiebbestückes
ineinander schieben und
mit Klemmband fixieren

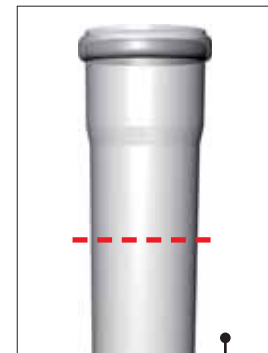

Innenrohr auf
benötigte Größe
ablängen

KONZENTRISCHES LUFT-ABGASSYSTEM

DN 60/100 – DN 200/300 mm

LIB - PPH/Edelstahl

LIL - PPH/Stahl weiß pulverbeschichtet

LIL / LIB -Rohr mit Muffe		NW	Art.-Nr. LIL	Art.-Nr. LIB	a (mm)	b (mm)	c (mm)	d (mm)
	250 mm	60 / 100	LPRL05	LPRB05	104	52	198	-
		80 / 125	LPRL08	LPRB08	130	52	198	-
		110 / 160	LPRL01	LPRB01	163	52	198	-
		125 / 180	LPRL02	LPRB02	182	-	-	-
		160 / 225	LPRL06	LPRB06	227	-	-	-
		200 / 300	LPRL00	LPRB00	302	-	-	-
	500 mm	60 / 100	LPRL55	LPRB55	104	52	448	-
		80 / 125	LPRL58	LPRB58	130	52	448	-
		110 / 160	LPRL51	LPRB51	163	52	448	-
		125 / 180	LPRL52	LPRB52	182	-	-	-
		160 / 225	LPRL56	LPRB56	227	-	-	-
		200 / 300	LPRL50	LPRB50	302	-	-	-
	1000 mm	60 / 100	LPRL15	LPRB15	104	52	948	-
		80 / 125	LPRL18	LPRB18	130	52	948	-
		110 / 160	LPRL11	LPRB11	163	52	948	-
		125 / 180	LPRL12	LPRB12	182	-	-	-
		160 / 225	LPRL16	LPRB16	227	-	-	-
		200 / 300	LPRL10	LPRB10	302	-	-	-

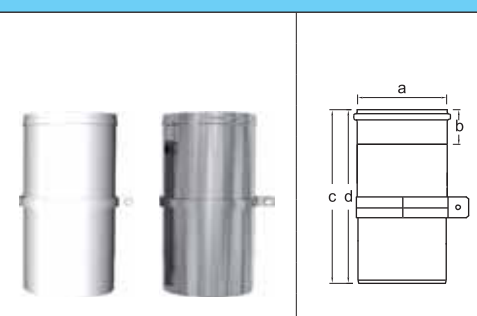
LIL / LIB-Schieberohr mit Klemmband		NW	Art.-Nr. LIL	Art.-Nr. LIB	a (mm)	b (mm)	c (mm)	d (mm)
	200 - 320 mm	60 / 100	LPSL25	LPSB25	100	52	180	310
		80 / 125	LPSL28	LPSB28	125	52	180	310
		110 / 160	LPSL21	LPSB21	160	52	180	310
		125 / 180	LPSL22	LPSB22	-	-	-	-
		160 / 225	LPSL26	LPSB26	-	-	-	-
		200 / 300	LPSL20	LPSB20	-	-	-	-
	290 - 500 mm	60 / 100	LPSL55	LPSB55	100	52	330	610
		80 / 125	LPSL58	LPSB58	125	52	370	660
		110 / 160	LPSL51	LPSB51	160	52	330	610
		125 / 180	LPSL52	LPSB52	-	-	-	-
		160 / 225	LPSL56	LPSB56	-	-	-	-
		200 / 300	LPSL50	LPSB50	-	-	-	-

LIL / LIB-Bogen 15°		NW	Art.-Nr. LIL	Art.-Nr. LIB	a (mm)	b (mm)	c (mm)	d (mm)
	60 / 100	LPBL15	LPBB15	104	52	87	65	
	80 / 125	LPBL18	LPBB18	130	52	82	65	
	110 / 160	LPBL11	LPBB11	163	52	82	70	
	125 / 180	LPBL12	LPBB12	182	-	-	-	
	160 / 225	LPBL16	LPBB16	227	-	-	-	
	200 / 300	LPBL10	LPBB10	302	-	-	-	

LIL / LIB-Bogen 30°		NW	Art.-Nr. LIL	Art.-Nr. LIB	a (mm)	b (mm)	c (mm)	d (mm)
	60 / 100	LPBL35	LPBB35	104	52	92	78	
	80 / 125	LPBL38	LPBB38	130	52	97	85	
	110 / 160	LPBL31	LPBB31	163	52	102	90	
	125 / 180	LPBL32	LPBB32	182	-	-	-	
	160 / 225	LPBL36	LPBB36	227	-	-	-	
	200 / 300	LPBL30	LPBB30	302	-	-	-	

KONZENTRISCHES LUFT-ABGASSYSTEM

DN 60/100 – DN 200/300 mm

LIB - PPH/Edelstahl

LIL - PPH/Stahl weiß pulverbeschichtet

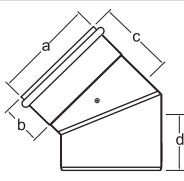
LIL / LIB-Bogen 45°		NW	Art.-Nr. LIL	Art.-Nr. LIB	a (mm)	b (mm)	c (mm)	d (mm)
 LIL LIB		60 / 100	LPBL45	LPBB45	104	52	97	95
		80 / 125	LPBL48	LPBB48	130	52	97	80
		110 / 160	LPBL41	LPBB41	163	52	122	115
		125 / 180	LPBL42	LPBB42	182	-	-	-
		160 / 225	LPBL46	LPBB46	227	-	-	-
		200 / 300	LPBL40	LPBB40	302	-	-	-

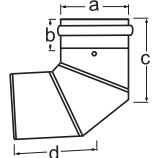
LIL / LIB-Bogen 87°		NW	Art.-Nr. LIL	Art.-Nr. LIB	a (mm)	b (mm)	c (mm)	d (mm)
 LIL LIB		60 / 100	LPBL95	LPBB95	104	52	135	123
		80 / 125	LPBL98	LPBB98	130	52	157	135
		110 / 160	LPBL91	LPBB91	163	52	176	151
		125 / 180	LPBL92	LPBB92	182	-	-	-
		160 / 225	LPBL96	LPBB96	227	-	-	-
		200 / 300	LPBL90	LPBB90	302	-	-	-

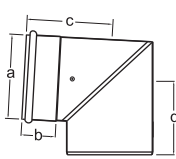
LIL-Kurzbogen 87°		NW	Art.-Nr. LIL	Art.-Nr. LIB	a (mm)	b (mm)	c (mm)	d (mm)
 LIL		60 / 100	LPBLK5	LPBBK5	104	52	125	95
		80 / 125	LPBLK8	LPBBK8	130	52	130	110
		110 / 160	LPBLK1	LPBBK1	163	52	140	130
		125 / 180	LPBLK2	LPBBK2	182	-	-	-
		160 / 225	LPBLK6	LPBBK6	227	-	-	-
		200 / 300	LPBLK0	LPBBK0	302	-	-	-

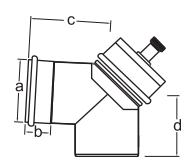
LIL-Revi-Bogen 87° mit Messöffnung		NW	Art.-Nr. LIL	Art.-Nr. LIB	a (mm)	b (mm)	c (mm)	d (mm)
 LIL		60 / 100	LPRLM5	LPRBM5	104	52	125	95
		80 / 125	LPRLM8	LPRBM8	130	52	130	110
		110 / 160	LPRLM1	LPRBM1	163	52	140	130
		125 / 180	LPRLM2	LPRBM2	182	-	-	-
		160 / 225	LPRLM6	LPRBM6	227	-	-	-
		200 / 300	LPRLM0	LPRBM0	302	-	-	-

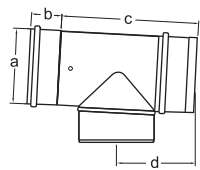
LIL / LIB-Umlenk-Stück mit Revisionsdeckel		NW	Art.-Nr. LIL	Art.-Nr. LIB	a (mm)	b (mm)	c (mm)	d (mm)
 LIL LIB		60 / 100	LPUL05	LPUB05	104	52	250	125
		80 / 125	LPUL08	LPUB08	130	52	290	140
		110 / 160	LPUL01	LPUB01	163	52	335	170
		125 / 180	LPUL02	LPUB02	182	80	440	260
		160 / 225	LPUL06	LPUB06	227	80	440	260
		200 / 300	LPUL00	LPUB00	302	80	440	260

KONZENTRISCHES LUFT-ABGASSYSTEM

DN 60/100 – DN 200/300 mm

LIB - PPH/Edelstahl

LIL - PPH/Stahl weiß pulverbeschichtet

LIL / LIB-Revisions-T-Stück		NW	Art.-Nr. LIL	Art.-Nr. LIB	a (mm)	b (mm)	c (mm)	d (mm)
		60 / 100	LPRTL5	LPRTB5	104	52	230	142
		80 / 125	LPRTL8	LPRTB8	130	52	270	142
		110 / 160	LPRTL1	LPRTB1	163	52	330	152
		125 / 180	LPRTL2	LPRTB2	182	80	380	220
		160 / 225	LPRTL6	LPRTB6	227	80	380	220
		200 / 300	LPRTL0	LPRTB0	302	80	380	220

LIL / LIB-Revisions-T-Stück mit Messöffnung		NW	Art.-Nr. LIL	Art.-Nr. LIB	a (mm)	b (mm)	c (mm)	d (mm)
		60 / 100	LPRML5	LPRMB5	104	52	230	175
		80 / 125	LPRML8	LPRMB8	130	52	270	180
		110 / 160	LPRML1	LPRMB1	163	52	330	210
		125 / 180	LPRML2	LPRMB2	182	80	380	-
		160 / 225	LPRML6	LPRMB6	227	80	380	-
		200 / 300	LPRML0	LPRMB0	302	80	380	-

LIL / LIB-Ablauf-T- Stück		NW	Art.-Nr. LIL	Art.-Nr. LIB	a (mm)	b (mm)	c (mm)	d (mm)
		60 / 100	LPRLA5	LPRBA5	104	52	178	185
		80 / 125	LPRLA8	LPRBA8	130	52	218	190
		110 / 160	LPRLA1	LPRBA1	163	52	278	220
		125 / 180	LPRLA2	LPRBA2	182	-	-	-
		160 / 225	LPRLA6	LPRBA6	227	-	-	-
		200 / 300	LPRLA0	LPRBA0	302	-	-	-

LIL / LIB-Umlenk-T-Stück mit Ablauf		NW	Art.-Nr. LIL	Art.-Nr. LIB	a (mm)	b (mm)	c (mm)	d (mm)
		60 / 100	LPULA5	LPUBA5	104	52	238	165
		80 / 125	LPULA8	LPUBA8	130	52	288	190
		110 / 160	LPULA1	LPUBA1	163	52	323	210
		125 / 180	LPULA2	LPUBA2	182	-	-	-
		160 / 225	LPULA6	LPUBA6	227	-	-	-
		200 / 300	LPULA0	LPRBA0	302	-	-	-

LIL / LIB-Verbindung-T-Stück		NW	Art.-Nr. LIL	Art.-Nr. LIB	a (mm)	b (mm)	c (mm)	d (mm)
		60 / 100	LPVTL5	LPVTB5	104	52	250	125
		80 / 125	LPVTL8	LPVTB8	130	52	290	140
		110 / 160	LPVTL1	LPVTB1	163	52	335	170
		125 / 180	LPVTL2	LPVTB2	-	-	-	-
		160 / 225	LPVTL6	LPVTB6	-	-	-	-
		200 / 300	LPVTL0	LPVTB0	-	-	-	-

LIL / LIB-Kondensatfalle waagrecht/senkrecht		NW	Art.-Nr. LIL	Art.-Nr. LIB	a (mm)	b (mm)	c (mm)	d (mm)
		60 / 100	LPKFL5	LPKFB5	104	80	80	100
		80 / 125	LPKFL8	LPKFB8	130	82	80	130
		110 / 160	LPKFL1	LPKFB1	163	82	80	150
		125 / 180	LPKFL2	LPKFB2	-	-	-	-
		160 / 225	LPKFL6	LPKFB6	-	-	-	-
		200 / 300	LPKFL0	LPKFB0	-	-	-	-

KONZENTRISCHES LUFT-ABGASSYSTEM

DN 60/100 – DN 200/300 mm

LIB - PPH/Edelstahl

LIL - PPH/Stahl weiß pulverbeschichtet

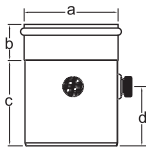

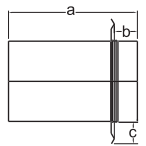
LIL / LIB-Mess-Stück mit 2 Messöffnungen		NW	Art.-Nr. LIL	Art.-Nr. LIB	a (mm)	b (mm)	c (mm)	d (mm)
 <p>LIL LIB</p>		60 / 100	LPMSL5	LPMSB5	104	52	105	80
		80 / 125	LPMSL8	LPMSB8	130	52	105	80
		110 / 160	LPMSL1	LPMSB1	163	52	105	80
		125 / 180	LPMSL2	LPMSB2	182	80	185	80
		160 / 225	LPMSL6	LPMSB6	227	80	185	80
		200 / 300	LPMSL0	LPMSB0	302	80	185	80

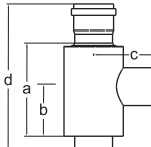
LIL-Schacht-Anschluss-Stück		NW	Art.-Nr. LIL	Art.-Nr. LIB	a (mm)	b (mm)	c (mm)	d (mm)
 <p>LIL</p>		60 / 100	LPSAL5	LPSAB5	175	50	45	-
		80 / 125	LPSAL8	LPSAB8	175	50	45	-
		110 / 160	LPSAL1	LPSAB1	175	50	45	-
		125 / 180	LPSAL2	LPSAB2	-	-	-	-
		160 / 225	LPSAL6	LPSAB6	-	-	-	-
		200 / 300	LPSAL0	LPSAB0	-	-	-	-

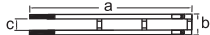
LIL / LIB-Zuluft-T-Stück		NW	Art.-Nr. LIL	Art.-Nr. LIB	a (mm)	b (mm)	c (mm)	d (mm)
 <p>LIL LIB</p>		60 / 100	LPZTL5	LPZTB5	140	80	100	260
		80 / 125	LPZTL8	LPZTB8	190	113	113	298
		110 / 160	LPZTL1	LPZTB1	190	105	130	340
		125 / 180	LPZTL2	LPZTB2	210	110	142	370
		160 / 225	LPZTL6	LPZTB6	240	130	173	405
		200 / 300	LPZTL0	LPZTB0	300	163	216	525

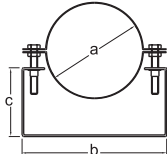
LIL-Klemmband		NW	Art.-Nr. LIL	Art.-Nr. LIB	a (mm)	b (mm)	c (mm)	d (mm)
 <p>LIL</p>		60 / 100	LPKLL5	LPKLB5	365	45	25	-
		80 / 125	LPKLL8	LPKLB8	440	45	25	-
		110 / 160	LPKLL1	LPKLB1	550	45	25	-
		125 / 180	LPKLL2	LPKLB2	-	-	-	-
		160 / 225	LPKLL6	LPKLB6	-	-	-	-
		200 / 300	LPKLL0	LPKLB0	-	-	-	-

LIL-Decken-Wand-Halterung		NW	Art.-Nr. LIL	Art.-Nr. LIB	a (mm)	b (mm)	c (mm)	d (mm)
 <p>LIL</p>		60 / 100	LPWHL5	LPWHB5	100	165	90	-
		80 / 125	LPWHL8	LPWHB8	150	190	90	-
		110 / 160	LPWHL1	LPWHB1	160	220	115	-
		125 / 180	LPWHL2	LPWHB2	-	-	-	-
		160 / 225	LPWHL6	LPWHB6	-	-	-	-
		200 / 300	LPWHL0	LPWHB0	-	-	-	-

LIL-Verlängerung für Decken-Wand-Halterung I		NW	Art.-Nr. LIL	Art.-Nr. LIB	a (mm)	b (mm)	c (mm)	d (mm)
 <p>LIL</p>		60 / 100	LPV1L5	LPV1B5	-	-	-	-
		80 / 125	LPV1L8	LPV1B8	100	185	2	2
		110 / 160	LPV1L1	LPV1B1	100	230	10	2
		125 / 180	LPV1L2	LPV1B2	-	-	-	-
		160 / 225	LPV1L6	LPV1B6	-	-	-	-
		200 / 300	LPV1L0	LPV1B0	-	-	-	-



KONZENTRISCHES LUFT-ABGASSYSTEM

DN 60/100 – DN 200/300 mm

LIB - PPH/Edelstahl

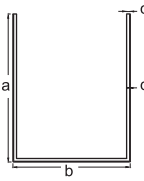
LIL - PPH/Stahl weiß pulverbeschichtet

LIL-Verlängerung für Decken-Wand-Halterung II		NW	Art.-Nr. LIL	Art.-Nr. LIB	a (mm)	b (mm)	c (mm)	d (mm)
 LIL		60 / 100	LPV2L5	LPV2B5	-	-	-	-
		80 / 125	LPV2L8	LPV2B8	250	185	2	2
		110 / 160	LPV2L1	LPV2B1	250	230	10	2
		125 / 180	LPV2L2	LPV2B2	-	-	-	-
		160 / 225	LPV2L6	LPV2B6	-	-	-	-
		200 / 300	LPV2L0	LPV2B0	-	-	-	-

LIL-Verlängerung für Decken-Wand-Halterung III		NW	Art.-Nr. LIL	Art.-Nr. LIB	a (mm)	b (mm)	c (mm)	d (mm)
 LIL		60 / 100	LPV3L5	LPV3B5	-	-	-	-
		80 / 125	LPV3L8	LPV3B8	335	185	2	2
		110 / 160	LPV2L1	LPV2B1	335	230	10	2
		125 / 180	LPV3L2	LPV3B2	-	-	-	-
		160 / 225	LPV3L6	LPV3B6	-	-	-	-
		200 / 300	LPV3L0	LPV3B0	-	-	-	-

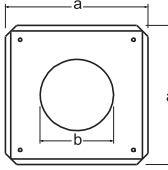
LIL / LIB-Abdeckblende einteilig		NW	Art.-Nr. LIL	Art.-Nr. LIB	a (mm)	b (mm)	c (mm)	d (mm)
 LIL LIB		60 / 100	LPWL05	LPWB05	250	103	-	-
		80 / 125	LPWL08	LPWB08	250	128	-	-
		110 / 160	LPWL01	LPWB01	230	165	-	-
		125 / 180	LPWL02	LPWB02	-	-	-	-
		160 / 225	LPWL06	LPWB06	-	-	-	-
		200 / 300	LPWL00	LPWB00	-	-	-	-

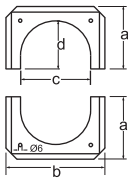

LIL / LIB-Abdeckblende zweiteilig		NW	Art.-Nr. LIL	Art.-Nr. LIB	a (mm)	b (mm)	c (mm)	d (mm)
 LIL LIB		60 / 100	LPW2L5	LPW2B5	115	160	101	85
		80 / 125	LPW2L8	LPW2B8	145	180	127	120
		110 / 160	LPW2L1	LPW2B1	165	230	165	130
		125 / 180	LPW2L2	LPW2B2	-	-	-	-
		160 / 225	LPW2L6	LPW2B6	-	-	-	-
		200 / 300	LPW2L0	LPW2B0	-	-	-	-

KONZENTRISCHES LUFT-ABGASSYSTEM

DN 60/100 – DN 200/300 mm

LIB - PPH/Edelstahl

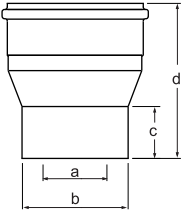
LIL - PPH/Stahl weiß pulverbeschichtet



LIL / LIB-Kesseladapter		NW	Art.-Nr. LIL	Art.-Nr. LIB	a (mm)	b (mm)	c (mm)	d (mm)
		60 / 100	LPKL51	LPKB51	63	96	65	120
		60 / 100	LPKL52	LPKB52	70	110	95	150
		60 / 100	LPKL53	LPKB53	80	110	95	150
		60 / 100	LPKL54	LPKB54	80	126	75	150
		80 / 125	LPKL01	LPKB01	60	100	47	120
		80 / 125	LPKL02	LPKB02	63	96	45	125
		80 / 125	LPKL03	LPKB03	70	100	45	120
		80 / 125	LPKL85	LPKB85	70	110	45	120
		80 / 125	LPKL81	LPKB81	80	110	45	120
		80 / 125	LPKL04	LPKB04	80	122	60	120
		80 / 125	LPKL83	LPKB83	80	126	65	120
		80 / 125	LPKL84	LPKB84	80	130	40	120
		80 / 125	LPKL82	LPKB82	100	150	70	150
		110 / 160	LPKL11	LPKB11	80	110	60	145
		110 / 160	LPKL06	LPKB06	80	125	60	145
		110 / 160	LPKL07	LPKB07	100	130	60	145
		110 / 160	LPKL09	LPKB09	100	150	60	150
		125 / 180	LPKL21	LPKB21	80	110	-	-
		125 / 180	LPKL22	LPKB22	80	125	-	-
		125 / 180	LPKL23	LPKB23	100	150	-	-
		125 / 180	LPKL24	LPKB24	110	160	-	-
		160 / 225	LPKL61	LPKB61	100	150	-	-
		160 / 225	LPKL62	LPKB62	110	160	-	-
		160 / 225	LPKL63	LPKB63	125	180	-	-
200 / 300	LPKLY1	LPKBY1	100	150	-	-		
200 / 300	LPKLY2	LPKBY2	110	160	-	-		
200 / 300	LPKLY3	LPKBY3	125	180	-	-		
200 / 300	LPKLY4	LPKBY4	160	225	-	-		

KONZENTRISCHES LUFT-ABGASSYSTEM

DN 60/100 – DN 200/300 mm

LIB - PPH/Edelstahl

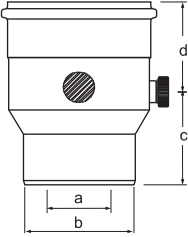
LIL - PPH/Stahl weiß pulverbeschichtet



LIL / LIB-Mess-Stück reduziert		NW	Art.-Nr. LIL	Art.-Nr. LIB	a (mm)	b (mm)	c (mm)	d (mm)
		60 / 100	LPML51	LPMB51	63	96	-	-
		60 / 100	LPML52	LPMB52	70	110	-	-
		60 / 100	LPML53	LPMB53	80	110	-	-
		60 / 100	LPML54	LPMB54	80	126	-	-
		80 / 125	LPML81	LPMB81	60	100	110	75
		80 / 125	LPML82	LPMB82	63	96	110	75
		80 / 125	LPML83	LPMB83	70	110	85	75
		80 / 125	LPML84	LPMB84	80	110	85	75
		80 / 125	LPML85	LPMB85	80	126	85	75
		80 / 125	LPML86	LPMB86	80	130	85	75
		110 / 160	LPML11	LPMB11	80	110	120	75
		110 / 160	LPML12	LPMB12	80	125	110	75
		110 / 160	LPML13	LPMB13	100	150	90	75
		125 / 180	LPML21	LPMB21	80	110	-	-
		125 / 180	LPML22	LPMB22	80	125	-	-
		125 / 180	LPML23	LPMB23	100	150	-	-
		125 / 180	LPML24	LPMB24	110	160	-	-
		160 / 225	LPML61	LPMB61	100	150	-	-
		160 / 225	LPML62	LPMB62	110	160	-	-
		160 / 225	LPML63	LPMB63	125	180	-	-
		200 / 300	LPML01	LPMB01	100	150	-	-
		200 / 300	LPML02	LPMB02	110	160	-	-
		200 / 300	LPML03	LPMB03	125	180	-	-
		200 / 300	LPML04	LPMB04	160	225	-	-



KONZENTRISCHES LUFT-ABGASSYSTEM

DN 60/100 – DN 200/300 mm

LIB - PPH/Edelstahl

LIL - PPH/Stahl weiß pulverbeschichtet

LIL / LIB-Umlenk-T-Stück mit MÖ reduziert		NW	Art.-Nr. LIL	Art.-Nr. LIB	a (mm)	b (mm)	c (mm)	d (mm)
LIL		60 / 100	LPTL51	LPTB51	63	96	165	290
		60 / 100	LPTL52	LPTB52	70	110	165	290
		60 / 100	LPTL53	LPTB53	80	110	165	290
		60 / 100	LPTL54	LPTB54	80	126	165	290
		80 / 125	LPTL81	LPTB81	60	100	190	340
		80 / 125	LPTL82	LPTB82	63	96	190	340
		80 / 125	LPTL83	LPTB83	70	110	190	340
		80 / 125	LPTL84	LPTB84	80	110	190	340
		80 / 125	LPTL85	LPTB85	80	126	190	340
		80 / 125	LPTL86	LPTB86	80	130	190	340
LIB		110 / 160	LPTL11	LPTB11	80	110	210	375
		110 / 160	LPTL12	LPTB12	80	125	210	375
		110 / 160	LPTL13	LPTB13	100	150	210	375
		125 / 180	LPTL21	LPTB21	80	110	-	-
		125 / 180	LPTL22	LPTB22	80	125	-	-
		125 / 180	LPTL23	LPTB23	100	150	-	-
		125 / 180	LPTL24	LPTB24	110	160	-	-
		160 / 225	LPTL61	LPTB61	100	150	-	-
		160 / 225	LPTL62	LPTB62	110	160	-	-
		160 / 225	LPTL63	LPTB63	125	180	-	-
		200 / 300	LPTL01	LPTB01	100	150	-	-
		200 / 300	LPTL02	LPTB02	110	160	-	-
		200 / 300	LPTL03	LPTB03	125	180	-	-
		200 / 300	LPTL04	LPTB04	160	225	-	-

LIL / LIB-Umlenk-T-Stück als Kesselanschluss		NW	Art.-Nr. LIL	Art.-Nr. LIB	a (mm)	b (mm)	c (mm)	d (mm)
LIL		60 / 100			63	96	-	290
		60 / 100			70	110	-	290
		60 / 100			80	110	-	290
		60 / 100			80	126	-	290
		80 / 125			60	100	-	340
		80 / 125			63	96	-	340
		80 / 125			70	110	-	340
		80 / 125			80	110	-	340
		80 / 125			80	126	-	340
		80 / 125			80	130	-	340
LIB		110 / 160			80	110	-	375
		110 / 160			80	125	-	375
		110 / 160			100	150	-	375
		125 / 180			80	110	-	-
		125 / 180			80	125	-	-
		125 / 180			100	150	-	-
		125 / 180			110	160	-	-
		160 / 225			100	150	-	-
		160 / 225			110	160	-	-
		160 / 225			125	180	-	-
		200 / 300			100	150	-	-
		200 / 300			110	160	-	-
		200 / 300			125	180	-	-
		200 / 300			160	225	-	-